

# **Distributed Systems**

(3rd Edition)

Maarten van Steen    Andrew S. Tanenbaum

## Chapter 01: Introduction

Edited by: Hicham G. Elmongui

# Distributed System

## Definition

A distributed system is a collection of **autonomous computing elements** that appears to its users as a **single coherent system**.

## Characteristic features

- Autonomous computing elements, also referred to as **nodes**, be they hardware devices or software processes.
- Single coherent system: users or applications perceive a single system ⇒ nodes need to **collaborate**.

# Collection of autonomous nodes

## Independent behavior

Each node is autonomous and will thus have its **own notion of time**: there is no **global clock**. Leads to fundamental synchronization and coordination problems.

## Collection of nodes

- How to manage **group membership**?
- How to know that you are indeed communicating with an **authorized (non)member**?

# Organization

## Overlay network

Each node in the collection communicates only with other nodes in the system, its **neighbors**. The set of neighbors may be dynamic, or may even be known only implicitly (i.e., requires a lookup).

## Overlay types

Well-known example of overlay networks: **peer-to-peer systems**.

**Structured**: each node has a **well-defined set of neighbors** with whom it can communicate (tree, ring).

**Unstructured**: each node has references to **randomly selected other nodes** from the system.

# Coherent system

## Essence

The collection of nodes as a whole operates the same, no matter where, when, and how interaction between a user and the system takes place.

## Examples

- An end user cannot tell where a computation is taking place
- Where data is exactly stored should be irrelevant to an application
- If or not data has been replicated is completely hidden

Keyword is **distribution transparency**

## The snag: partial failures

It is inevitable that at any time **only a part** of the distributed system fails. Hiding partial failures and their recovery is often very difficult and in general impossible to hide.

# Middleware: the OS of distributed systems

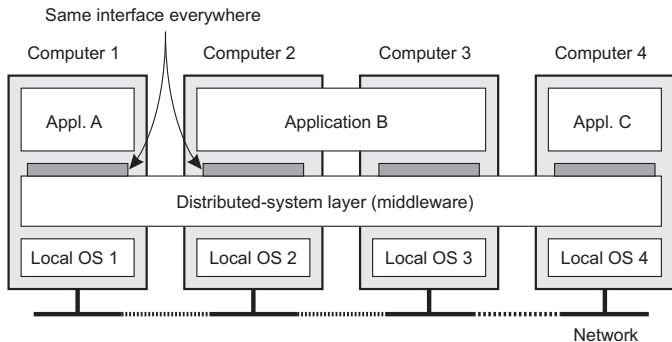

## What does it contain?

Commonly used components and functions that need not be implemented by applications separately.

# Middleware: the OS of distributed systems

Middleware services are offered in a networked environment:

- Resource management
- Facilities for interapplication communication.
- Security services.
- Accounting services.
- Masking of and recovery from failures.

Typical middleware services:

- Communication
- Transactions
- Service composition
- Reliability

# What do we want to achieve?

- Support sharing of resources
- Distribution transparency
- Openness
- Scalability



# Sharing resources

## Canonical examples

- Cloud-based shared storage and files
- Peer-to-peer assisted multimedia streaming
- Shared mail services (think of outsourced mail systems)
- Shared Web hosting (think of content distribution networks)

## Observation

*"The network is the computer"*

(quote from John Gage, then at Sun Microsystems)

# Distribution transparency

## Types

Transparency	Description
Access	Hide differences in data representation and how an object <sup>a</sup> is accessed
Location	Hide where an object is located
Relocation	Hide that an object may be moved to another location while in use
Migration	Hide that an object may move to another location
Replication	Hide that an object is replicated
Concurrency	Hide that an object may be shared by several independent users
Failure	Hide the failure and recovery of an object

<sup>a</sup>We use the term *object* to mean either a process or a resource.

# Degree of transparency

## Observation

Aiming at full distribution transparency may be too much:

- There are communication latencies that cannot be hidden
- **Completely hiding failures** of networks and nodes is (theoretically and practically) **impossible**
  - You cannot distinguish a slow computer from a failing one
  - You can never be sure that a server actually performed an operation before a crash
- Full transparency will **cost performance**, exposing distribution of the system
  - Keeping replicas **exactly** up-to-date with the master **takes time**
  - Immediately flushing write operations to disk for fault tolerance

# Degree of transparency

## Exposing distribution may be good

- Making use of location-based services (finding your nearby friends)
- When dealing with users in different time zones
- When it makes it easier for a user to understand what's going on (when e.g., a server does not respond for a long time, report it as failing).

## Conclusion

Distribution transparency is a nice a goal, but achieving it is a different story, and it should often not even be aimed at.

# Openness of distributed systems

## What are we talking about?

Be able to interact with services from other open systems, irrespective of the underlying environment:

- Systems should conform to well-defined **interfaces**
- Systems should easily **interoperate**
- Systems should support **portability** of applications
- Systems should be easily **extensible**

# Policies versus mechanisms

## Implementing openness: policies

- What level of consistency do we require for client-cached data?
- Which operations do we allow downloaded code to perform?
- Which QoS requirements do we adjust in the face of varying bandwidth?
- What level of secrecy do we require for communication?

## Implementing openness: mechanisms

- Allow (dynamic) setting of caching policies
- Support different levels of trust for mobile code
- Provide adjustable QoS parameters per data stream
- Offer different encryption algorithms

# Scale in distributed systems

## Observation

Many developers of modern distributed systems easily use the adjective “scalable” without making clear **why** their system actually scales.

## At least three components

- Number of users and/or processes (**size scalability**)
- Maximum distance between nodes (**geographical scalability**)
- Number of administrative domains (**administrative scalability**)

## Observation

Most systems account only, to a certain extent, for size scalability. Often a solution: multiple powerful servers operating independently in parallel. Today, the challenge still lies in geographical and administrative scalability.

# Size scalability

## Root causes for scalability problems with centralized solutions

- The computational capacity, limited by the CPUs
- The storage capacity, including the transfer rate between CPUs and disks
- The network between the user and the centralized service



# Problems with geographical scalability

- Cannot simply go from LAN to WAN: many distributed systems assume **synchronous client-server interactions**: client sends request and waits for an answer. **Latency** may easily prohibit this scheme.
- WAN links are often inherently **unreliable**: simply moving streaming video from LAN to WAN is bound to fail.
- **Lack of multipoint communication**, so that a simple search broadcast cannot be deployed. Solution is to develop separate **naming** and **directory services** (having their own scalability problems).

# Problems with administrative scalability

## Essence

Conflicting policies concerning usage (and thus payment), management, and security

## Examples

- **Computational grids**: share expensive resources between different domains.

## Exception: several peer-to-peer networks

- File-sharing systems (based, e.g., on BitTorrent)
- Peer-to-peer telephony (Skype)
- Peer-assisted audio streaming (Spotify)

Note: **end users** collaborate and not **administrative entities**.

# Techniques for scaling

**Scalability problems** in distributed systems appear as performance problems caused by **limited capacity of servers and network**

## Two solutions:

- **Scaling up:** improving their capacity (e.g., by increasing memory, upgrading CPUs, or replacing network modules)
- **Scaling out:** expanding the distributed system by essentially deploying more machines
  - Hiding communication latencies
  - Distribution of work
  - Replication

# Techniques for scaling

## Hide communication latencies

- Make use of [asynchronous communication](#)
- Have separate handler for incoming response
- **Problem:** not every application fits this model

# Techniques for scaling

Facilitate solution by moving computations to client

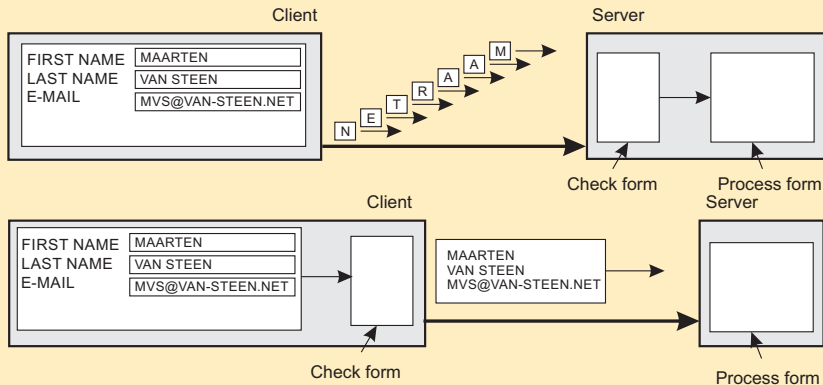

# Techniques for scaling

## Partition data and computations across multiple machines

- Move computations to clients (Java applets)
- Decentralized naming services (DNS)
- Decentralized information systems (WWW)

# Techniques for scaling

## Replication and caching: Make copies of data available at different machines

- Replicated file servers and databases
- Mirrored Web sites
- Web caches (in browsers and proxies)
- File caching (at server and client)

## Benefits of replication:

- increases availability
- helps to balance the load between components
- can hide much of the communication latency problems

## Caching

- A decision made by the client of a resource and not by the owner

# Scaling: The problem with replication

Applying replication is easy, except for one thing

- Having multiple copies (cached or replicated), leads to **inconsistencies**: modifying one copy makes that copy different from the rest.
- Always keeping copies consistent and in a general way requires **global synchronization** on each modification.
- Global synchronization precludes large-scale solutions.

## Observation

If we can tolerate inconsistencies, we may reduce the need for global synchronization, but **tolerating inconsistencies is application dependent**.



# Developing distributed systems: Pitfalls

## Observation

Many distributed systems are needlessly complex caused by mistakes that required patching later on. Many **false assumptions** are often made.

## False (and often hidden) assumptions

- The network is reliable
- The network is secure
- The network is homogeneous
- The topology does not change
- Latency is zero
- Bandwidth is infinite
- Transport cost is zero
- There is one administrator

# Three types of distributed systems

- High performance distributed computing systems
- Distributed information systems
- Distributed systems for pervasive computing

# Cluster computing

Essentially a group of high-end systems connected through a LAN

- Homogeneous: same OS, near-identical hardware
- Single managing node

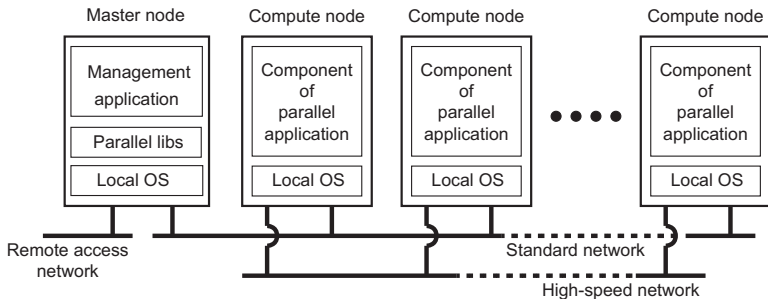

# Grid computing

The next step: lots of nodes from everywhere

- Heterogeneous
- Dispersed across several organizations
- Can easily span a wide-area network

## Note

To allow for collaborations, grids generally use **virtual organizations**. In essence, this is a grouping of users (or better: their IDs) that will allow for authorization on resource allocation.

# Architecture for grid computing

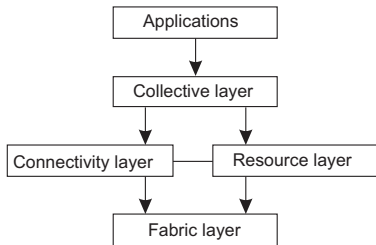

## The layers

**Fabric:** Provides interfaces to local resources (for querying state and capabilities, locking, etc.)

**Connectivity:** Communication/transaction protocols, e.g., for moving data between resources. Also various authentication protocols.

**Resource:** Manages a single resource, such as creating processes or reading data.

**Collective:** Handles access to multiple resources: discovery, scheduling, replication.

**Application:** Contains actual grid applications in a single organization.

# Cloud computing

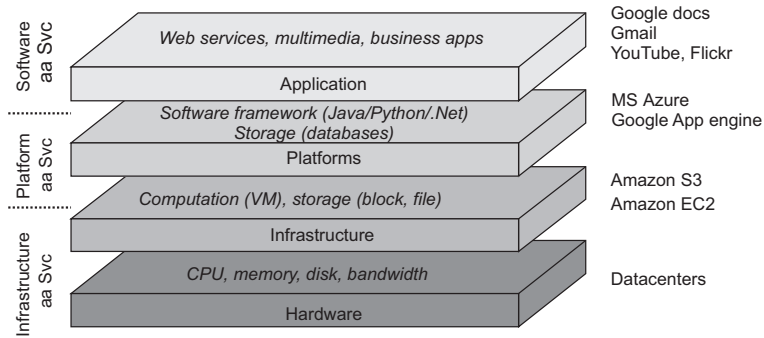

# Cloud computing

## Make a distinction between four layers

- **Hardware:** Processors, routers, power and cooling systems. Customers normally never get to see these.
- **Infrastructure:** Deploys virtualization techniques. Evolves around allocating and managing virtual storage devices and virtual servers.
- **Platform:** Provides higher-level abstractions for storage and such. Example: Amazon S3 storage system offers an API for (locally created) files to be organized and stored in so-called **buckets**.
- **Application:** Actual applications, such as office suites (text processors, spreadsheet applications, presentation applications). Comparable to the suite of apps shipped with OSes.

# Integrating applications

## Situation

Organizations confronted with many **networked applications**, but achieving interoperability was painful.

## Basic approach

A networked application is one that runs on a **server** making its services available to remote **clients**. Simple integration: clients combine requests for (different) applications; send that off; collect responses, and present a coherent result to the user.

## Next step

Allow direct application-to-application communication, leading to **Enterprise Application Integration**.



# Example EAI: (nested) transactions

## Transaction

Primitive	Description
<i>BEGIN_TRANSACTION</i>	Mark the start of a transaction
<i>END_TRANSACTION</i>	Terminate the transaction and try to commit
<i>ABORT_TRANSACTION</i>	Kill the transaction and restore the old values
<i>READ</i>	Read data from a file, a table, or otherwise
<i>WRITE</i>	Write data to a file, a table, or otherwise

## Issue: all-or-nothing

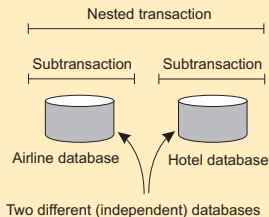

- **Atomic:** happens indivisibly (seemingly)
- **Consistent:** does not violate system invariants
- **Isolated:** not mutual interference
- **Durable:** commit means changes are permanent

# TPM: Transaction Processing Monitor

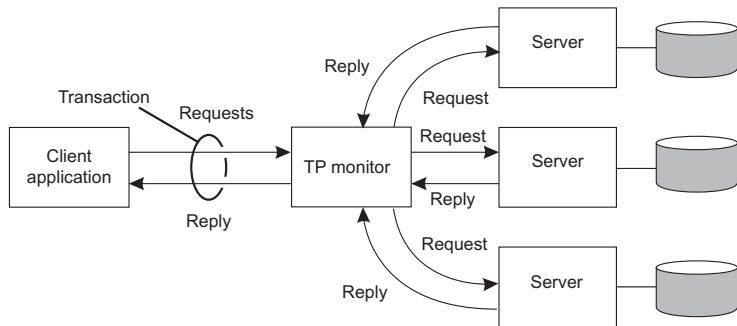

## Observation

In many cases, the data involved in a transaction is distributed across several servers. A **TP Monitor** is responsible for coordinating the execution of a transaction.

# Middleware and EAI

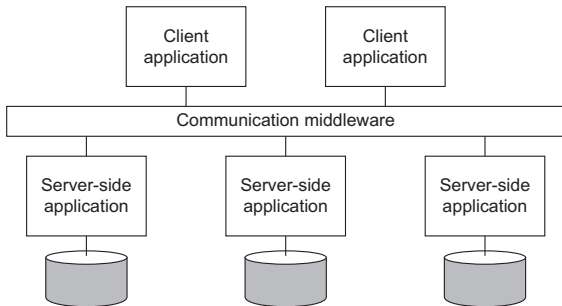

Middleware offers communication facilities for integration

**Remote Procedure Call (RPC):** Requests are sent through local procedure call, packaged as message, processed, responded through message, and result returned as return from call.

**Message Oriented Middleware (MOM):** Messages are sent to logical contact point (**published**), and forwarded to **subscribed** applications.

# Distributed pervasive systems

## Observation

Emerging next-generation of distributed systems in which nodes are small, mobile, and often embedded in a larger system, characterized by the fact that the system **naturally blends into the user's environment**.

## Three (overlapping) subtypes

- **Ubiquitous computing systems**: pervasive and **continuously present**, i.e., there is a continuous interaction between system and user.
- **Mobile computing systems**: pervasive, but emphasis is on the fact that devices are **inherently mobile**.
- **Sensor (and actuator) networks**: pervasive, with emphasis on the actual (collaborative) **sensing** and **actuation** of the environment.

# Ubiquitous systems

## Core elements

- 1 **(Distribution)** Devices are networked, distributed, and accessible in a transparent manner
- 2 **(Interaction)** Interaction between users and devices is highly unobtrusive
- 3 **(Context awareness)** The system is aware of a user's context in order to optimize interaction
- 4 **(Autonomy)** Devices operate autonomously without human intervention, and are thus highly self-managed
- 5 **(Intelligence)** The system as a whole can handle a wide range of dynamic actions and interactions

# Mobile computing

## Distinctive features

- A myriad of different mobile devices (smartphones, tablets, GPS devices, remote controls, active badges).
- Mobile implies that a device's location is expected to change over time  $\Rightarrow$  change of local services, reachability, etc. Keyword: **discovery**.
- Communication may become more difficult: no stable route, but also perhaps no guaranteed connectivity  $\Rightarrow$  **disruption-tolerant networking**.

# Sensor networks

## Characteristics

The **nodes** to which sensors are attached are:

- Many (10s-1000s)
- Simple (small memory/compute/communication capacity)
- Often battery-powered (or even battery-less)

# Sensor networks as distributed databases

## Two extremes

